

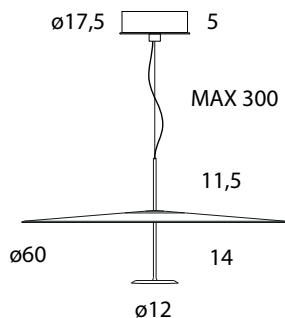





# DOT 600

Foster+Partners , 2015

Suspended lamp for indirect lighting with a 20W LED source and diffused light optic system.  
Aluminium structure with steel matt-painted reflector



<b>TECHNICAL DATAS</b>	Product Name (code)	<b>DOT 600 (cod.130)</b>
	Certificates	
	Norms	<b>EN 60598-1 / EN55015 / UL 2108:2015 / CSA C22.2#9.0:1996</b>
	Light sources	<b>23W LED [2700K / 3000K • 2350 lm]</b>
	Available	<b>230V (Europe) - 120V (USA - Japan) - 240V (UK)</b>
	Insulation Class	<b>I</b>
	Protection Class	<b>IP20</b>
Packaging	<b>0,170 m<sup>3</sup> - 10 Kg</b>	

<b>COLOURS</b>				
	<b>Col. 01XO</b> Anodised black	<b>Col. 03XO</b> Anodised red	<b>Col. 50XO</b> Anodised brass	<b>Col. 51XO</b> Anodised blue

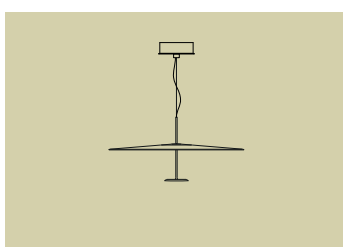
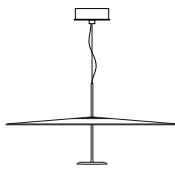
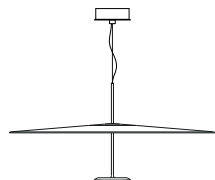
<b>FAMILY</b>			
	<b>DOT 600</b>	<b>DOT 800</b>	<b>DOT 1100</b>



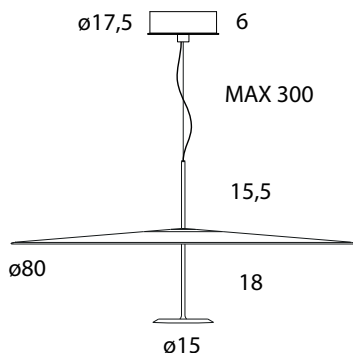

# DOT 800

Foster+Partners , 2015

Suspended lamp for indirect lighting with a 40W LED source and diffused light optic system.  
Aluminium structure with steel matt-painted reflector



<b>TECHNICAL DATAS</b>	Product Name (code)	<b>DOT 800 (cod. 131)</b>
	Certificates	
	Norms	<b>EN 60598-1 / EN55015 / UL 2108:2015 / CSA C22.2#9.0:1996</b>
	Light sources	<b>41W LED [2700K / 3000K • 3250 lm]</b>
	Available	<b>230V (Europe) - 120V (USA - Japan) - 240V (UK)</b>
	Insulation Class	<b>I</b>
	Protection Class	<b>IP20</b>
Packaging	<b>0,298 m<sup>3</sup> - 18 Kg</b>	

<b>COLOURS</b>				
	<b>Col. 01XO</b> Anodised black	<b>Col. 03XO</b> Anodised red	<b>Col. 50XO</b> Anodised brass	<b>Col. 51XO</b> Anodised blue

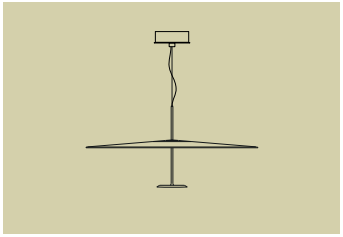
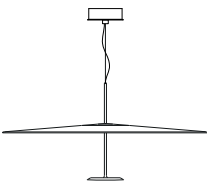
<b>FAMILY</b>			
	DOT 600	DOT 800	DOT 1100



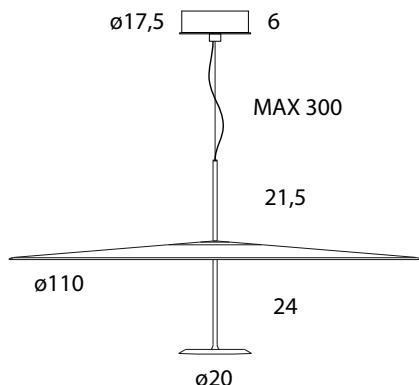

# DOT 1100

Foster+Partners , 2015

Suspended lamp for indirect lighting with a 60W LED source and diffused light optic system.  
Aluminium structure with steel matt-painted reflector



<b>TECHNICAL DATAS</b>	Product Name (code)	<b>DOT 1100 (cod. 132)</b>
	Certificates	
	Norms	<b>EN 60598-1 / EN55015 / UL 2108:2015 / CSA C22.2#9.0:1996</b>
	Light sources	<b>55W LED [2700K / 3000K • 4750 lm]</b>
	Available	<b>230V (Europe) - 120V (USA - Japan) - 240V (UK)</b>
	Insulation Class	<b>I</b>
	Protection Class	<b>IP20</b>
	Packaging	<b>0,560 m<sup>3</sup> - 25 Kg</b>

<b>COLOURS</b>				
	<b>Col. 01XO</b>	<b>Col. 03XO</b>	<b>Col. 50XO</b>	<b>Col. 51XO</b>
	Anodised black	Anodised red	Anodised brass	Anodised blue

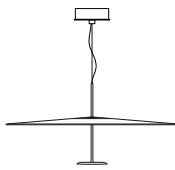
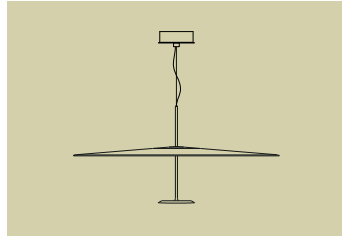
<b>FAMILY</b>			
	<b>DOT 600</b>	<b>DOT 800</b>	<b>DOT 1100</b>